



North American Manufacturer & Designer of Architectural Woodcarvings

# Flexible Tambour Panels

in SOLID WOOD



SOLID WOOD

# Flexible Tambour Panel

- ART FOR EVERYDAY Inc. manufactures a full line of standard Flexible Tambour Panels (FTP) from Premium Quality Lumber, with a total of **33 profiles**, in all available wood species.
- For **stain grade applications** we offer Alder, Cherry, Hard Maple, Hickory, Mahogany, Pine, Red Oak, White Oak and Walnut; and Soft Maple/Poplar for **paint grade applications**. Our FTP panels are **tested** for paint & stain applications.
- In addition to our standard FTP line (100 Series, 200, Series, etc.), ART FOR EVERYDAY Inc. manufactures **custom profiles** and **oversized panels** in all available wood species to achieve your desired look.
- Tambours are glued on a special **3M paper backer** for ease of installation to wrap around a surface or mount on curved area. We also offer FTP panels on special 3M super strong **double-sided** glue paper for ease of installation on any substrate.
- For better yield, panels can be ordered to your **specific sizes at no additional cost**. An exact panel size may vary due to tambour width dimension.
- For inquires **email us** at [sales@artforeverday.com](mailto:sales@artforeverday.com)  
Or **call**: (416) 645-5120 | Toll Free: 1 (866) 850-2680



Scan/Click for Quote





SOLID WOOD

# Flexible Tambour Panel

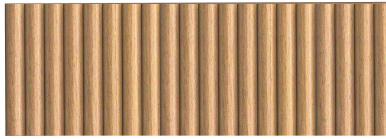

○ Alder

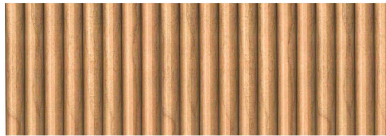

○ Cherry



○ Hard Maple



○ Hickory



○ Mahogany



○ Pine



○ Poplar

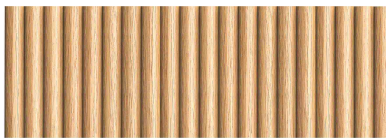

○ Red Oak



○ Soft Maple



○ Walnut

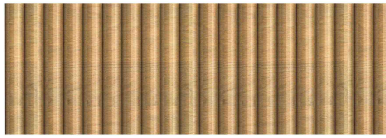

○ White Oak

## Vertical

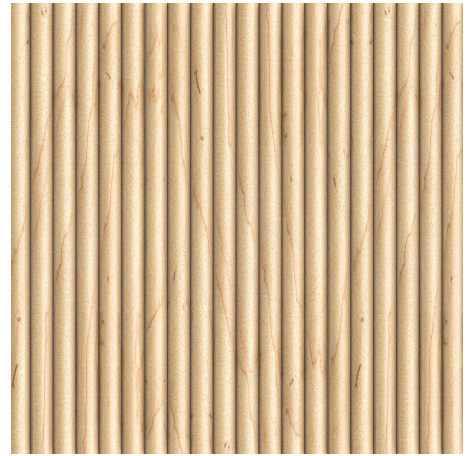

## Horizontal

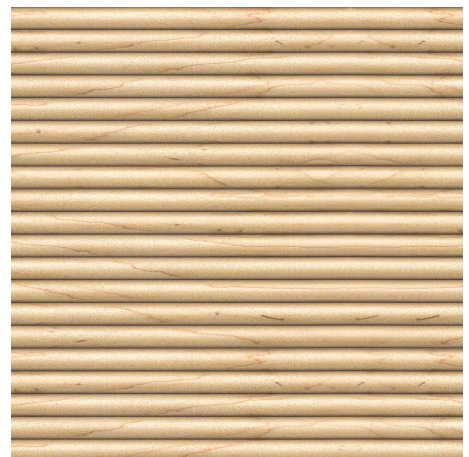

## Diagonal (Left/Right)

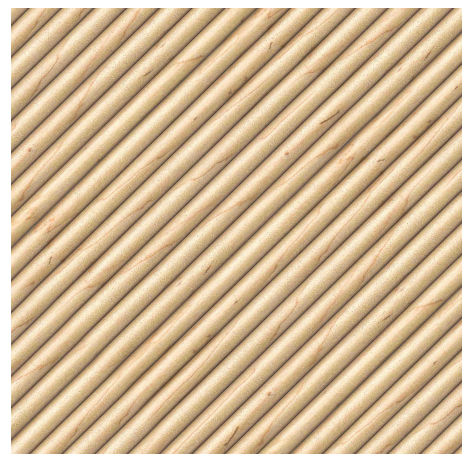

# 100 SERIES



FTP - 107

FTP - 101

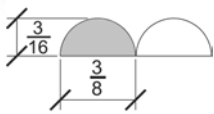

FTP - 103

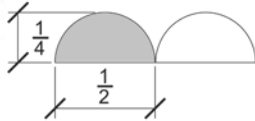

FTP - 105

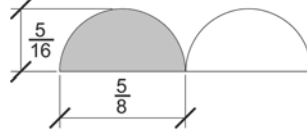

FTP - 107

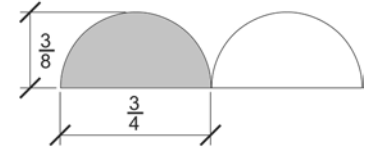

FTP - 109

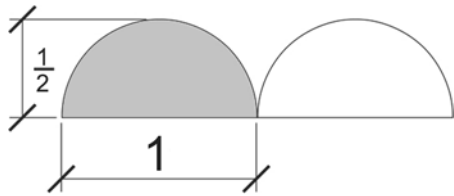

FTP - 111

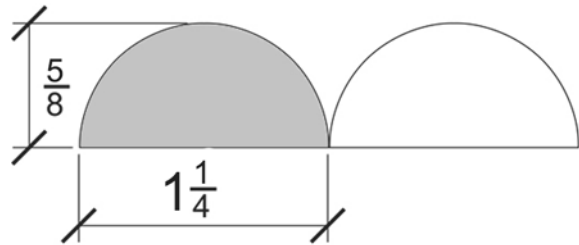

FTP - 113

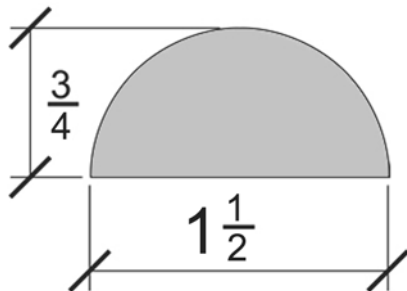

FTP - 115

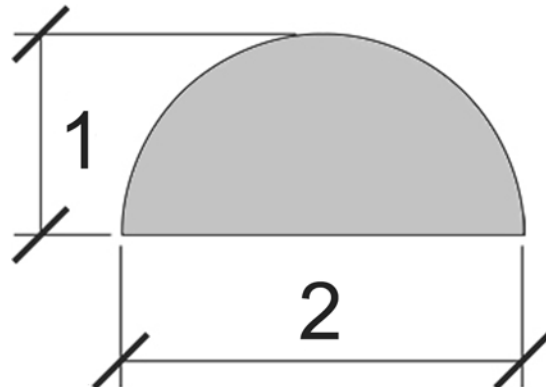



# 200 SERIES



FTP - 201

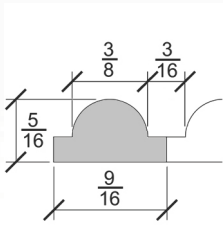

FTP - 203

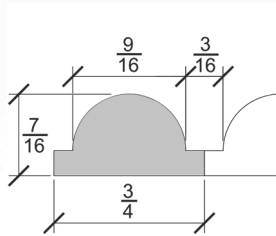

FTP - 205

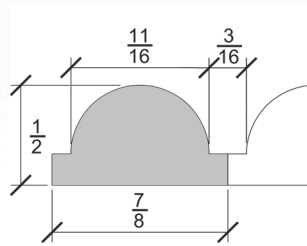

FTP - 207

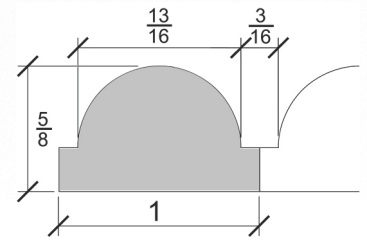

# 300 SERIES



FTP - 301

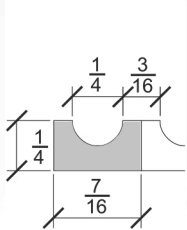

FTP - 303

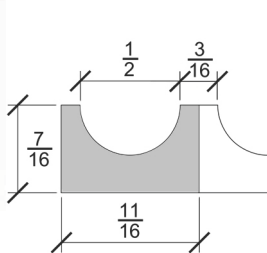

FTP - 305

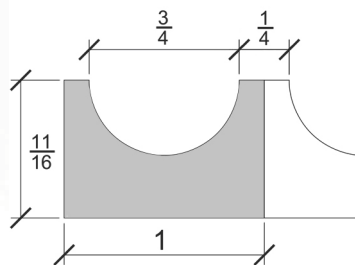

FTP - 307

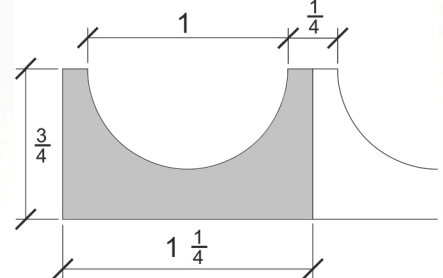

# 400 SERIES



FTP - 401

FTP - 403

FTP - 405

FTP - 407

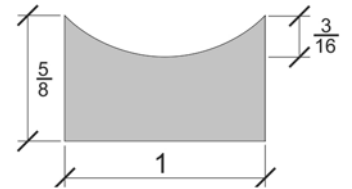
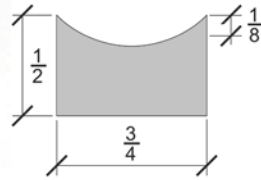
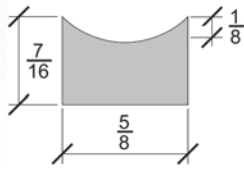
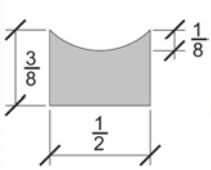

# 500 SERIES



FTP - 501

FTP - 503

FTP - 505

FTP - 507

FTP - 509

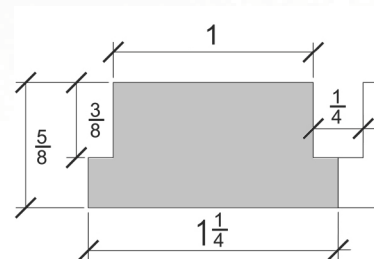
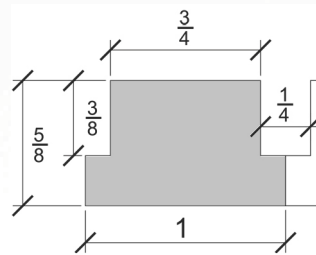
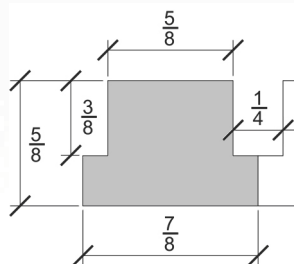
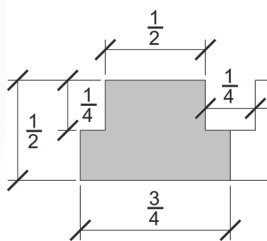
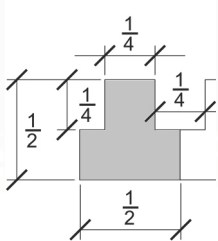



# 600 SERIES



FTP - 601

FTP - 603

FTP - 605

FTP - 607

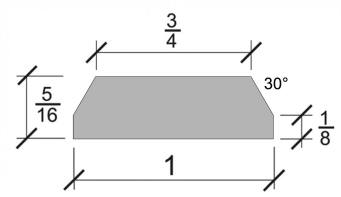
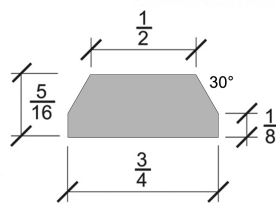
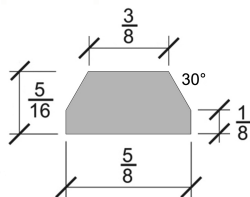
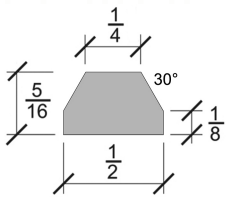

# 700 SERIES



FTP - 701

FTP - 703

FTP - 705

FTP - 707

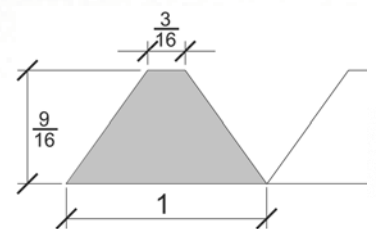
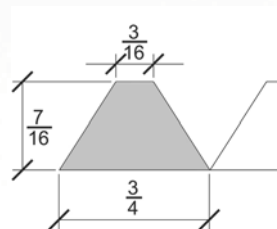
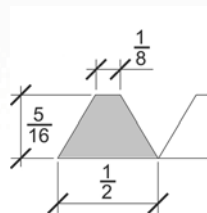
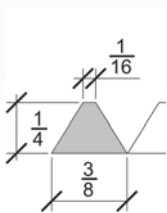



North American Manufacturer & Designer of Architectural Woodcarvings

Tel: (416) 645-5120 | Toll Free: 1 (866) 850-2680

[www.artforeverday.com](http://www.artforeverday.com) | [sales@artforeverday.com](mailto:sales@artforeverday.com)

Address: 420 Canarctic Drive, Toronto ON, M3J 2V3, Canada

    @artforeverday



Click For Quote

