

Fermeture Amortie Soft closing	Type	Capacité Capacity	Hauteur de porte Door height		Ressort Spring
			Min	Max	
BRA-SW-FN	TYPE F	4,4 kg-14,6 kg / 9,7 lb-32,1 lb	12 3/16"	24"	2 ressorts noir 2 black spring
			320 mm	610 mm	

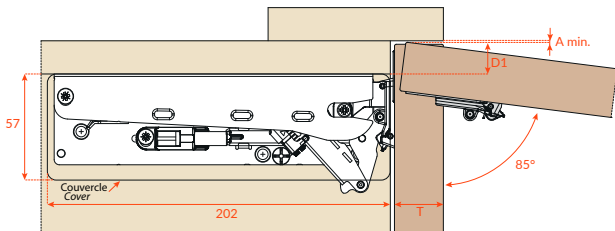



ADA-SW-TOP

Table de recouvrement avec adaptateur centrale ADA-SW-TOP

Overlay table with center bracket ADA-SW-TOP

K	D1
3	= 13
4	= 14
5	= 15
6	= 16
7	= 17

	T=	16	17	18	19	20	21	22	23	24	25	26
K=3	A = min	0	0.1	0.1	0.2	0.2	0.3	0.5	0.6	0.7	0.9	1.1
K=4	A = min	0	0.1	0.1	0.2	0.2	0.3	0.4	0.6	0.7	0.9	1.1
K=5	A = min	0	0.1	0.1	0.2	0.2	0.3	0.4	0.6	0.7	0.9	1.1
K=6	A = min	0	0.1	0.1	0.2	0.2	0.3	0.4	0.6	0.7	0.9	1.0
K=7	A = min	0	0.1	0.1	0.2	0.2	0.3	0.4	0.6	0.7	0.8	1.0

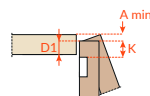
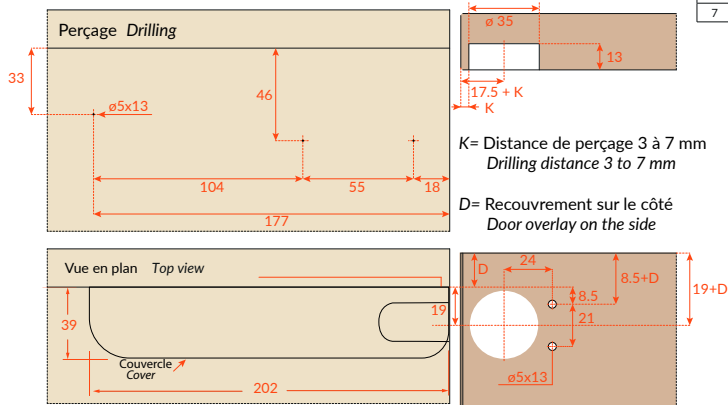
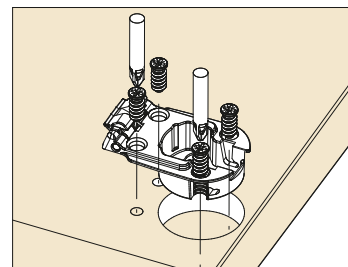
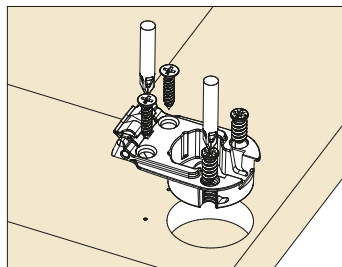
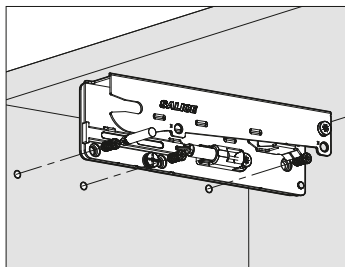
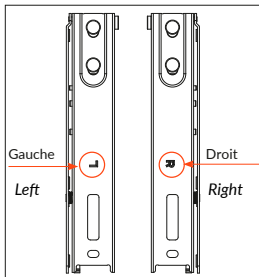

Table de recouvrement Overlay table

K	D1
3	= 16
4	= 17
5	= 18
6	= 19
7	= 20



MONTAGE DU SYSTÈME WIND WIND SYSTEM ASSEMBLY



Identifier les côtés respectifs des équerrés. Visser dans les côtés du meuble.

Identify right and left sides. Screw in the cabinet sides

Fixer les boîtiers sur la porte avec vis euro ou vis à bois selon le cas.

Screw the cup to the door with euro or wood screw.

Identifiez les côtés respectifs des bras et insérez-les dans le boîtier de support sur la porte. Cette étape ne requiert pas d'outils.

Identify right and left arms . Snap them into the cups. This is a tool-free operation.

Aligner et glisser les bras dans les supports. Assurez-vous de l'enclenchement à l'arrière.

Align and slide the arm in the support. Make sure it clips in the back.

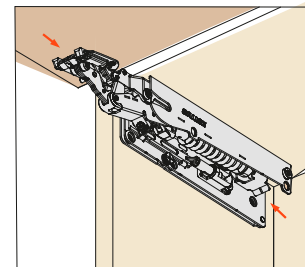
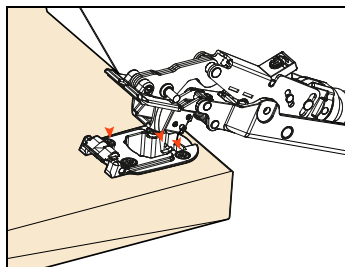
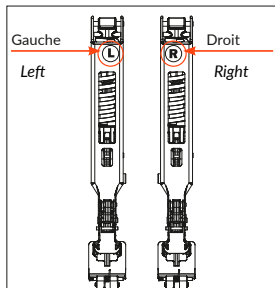

Assurez-vous que le derrière du système est bien retenu par la clip. Vous pouvez maintenant couper les attaches auto bloquantes.

Make sure that the arm is clipped on in the back.
You can now cut the zip tie on the arm.