

- Pour relier deux portes d'un caisson en coin à 90°
- Faible profondeur de perçage : 11,8 mm
- Épaisseur de porte jusqu'à 24 mm, réglage d'usine : 19 mm
- Sans amortisseur intégré
- Réglage tridimensionnel avec plaque de montage correspondante
- Écart minimum entre les portes
- For connecting 90° corner doors
- Cup depth of 11.8 mm
- Door thickness up to 24 mm preset to 19 mm
- Without damper
- 3-dimensional adjustment with corresponding mounting plate
- Minimum gap requirements

**PEN-GTLSG**

Penture Tiomos coin Lazy Susan avec goujons, sans amortisseur

Grass Tiomos pie-cut corner hinge with dowels, without damper

**PEN-GTLSB**

Penture Tiomos coin Lazy Susan fixation avec vis à bois, sans amortisseur

Grass Tiomos pie-cut corner hinge, wood screw fixing, without damper

Illustré avec plaque 0 mm

Shown with 0 mm mounting plate

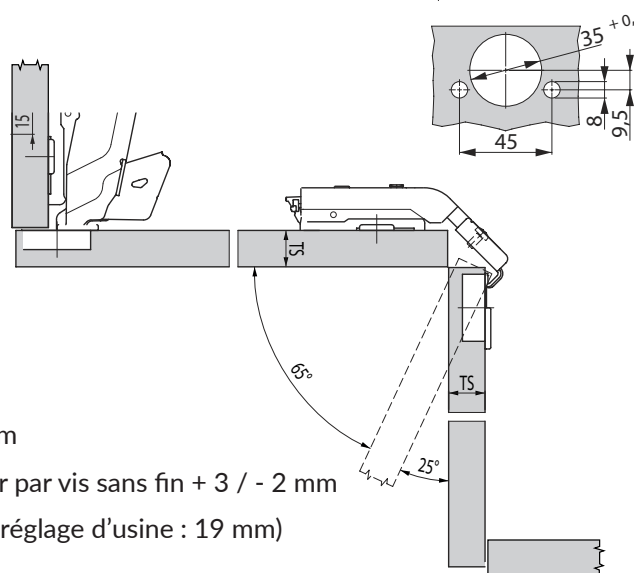
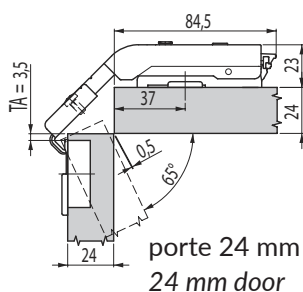
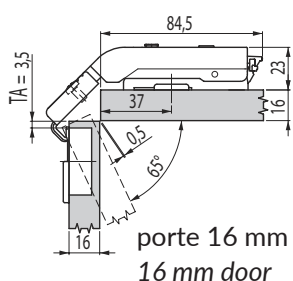
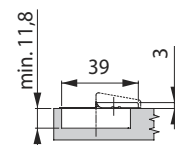
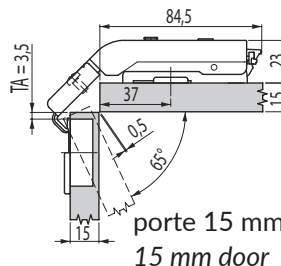
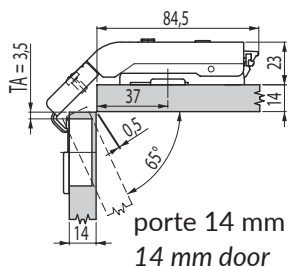
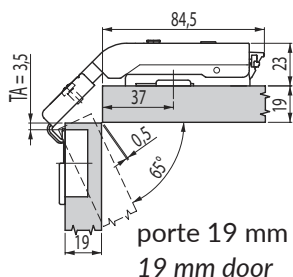

Réglage sur le bras de la penture :

1. Réglage latéral sans palier de  $\pm 2$  mm
2. Réglage de la profondeur sans palier par vis sans fin + 3 / - 2 mm
3. Épaisseur de porte de 14 à 24 mm (réglage d'usine : 19 mm)

Adjustment on the hinge arm:

1. Smooth  $\pm 2$  mm lateral adjustment
2. Smooth +3 / - 2 mm depth adjustment via worm screw principle
3. Door thickness of 14 to 24 mm (preset set at 19 mm)

